

# PowerAmp Design

EVALUATION KIT FOR MODELS PAD115/ PAD118/ PAD119

EVAL118

Rev I

## INTRODUCTION

The EVAL118 assembled evaluation kit provides a convenient method to become familiar with the operation of the operational amplifier models PAD115, PAD118 and PAD119 before your application circuit is committed to production. Some assembly is required since some user selections are needed depending on the application. For example, a current limit resistor value needs to be selected by the user. Also, there are several PCB mounting options available.

Critical connections for power supply bypassing and compensation are pre-wired. Connections are also provided for implementing fold-over current limit as well as standard current limit with the optional PAD125 Current Limit Accessory Module. Fold-over current limit components are not provided since each application will have different requirements. Diode clamps on each power supply and the output connections are provided for those applications in which significant inductive kickback may be found. Terminal strips are also provided for input and output signals and power.

## ASSEMBLY STEPS

*Please note that the #1 cause of problems for evaluation kit users is not reading and following the directions (all of them). The #2 cause of problems is poor solder joints (cold or bridging). Don't become a statistic. ✓ each step.*

Refer to the Illustrated Parts List for the components mentioned in each assembly step. Note that some heavy PCB copper planes and some heavy component leads are soldered in this kit. This may require a larger soldering iron tip and/or higher soldering iron temperatures than might normally be used. These steps are marked with an asterisk (\*).

- 1. Notice that the printed circuit board (PCB) is labeled on one side as the "DUT SIDE" and the other side as "CIRCUIT" side.
- 2. Refer to "Jumper Selection" below the Circuit Diagram for the EVAL118 on page 4. Install the required jumpers at the locations indicated depending on the options you have chosen. Note that the kit comes already wired for Option 1. Remove and insert jumpers as needed for the option you have chosen. Refer to the datasheet for the PAD125 for complete information on current limit options.
- \*3. This step may require a soldering temperature higher than normal and/or a larger soldering iron tip. Three current limiting sense resistors,  $R_S$ , are provided; one  $0.005\Omega$ , one  $0.010\Omega$  and one  $0.015\Omega$ . Refer to the data sheet for the PAD125 to determine which resistor value best fits your



Assembled EVAL118 with amplifier mounted.  
Optional accessory also modules shown.

application (if you have chosen not to use the current limit accessory module select the  $0.005\Omega$  resistor or install a length of heavy buss wire into the outer two holes at the location for the sense resistor  $R_S$ ). Smear a small amount of heat sink grease on the back of the selected resistor and then attach the resistor to heat sink HS1 at  $R_S$  with a 4-40 X  $\frac{1}{2}$ " screw and nut. The plastic nut driver supplied with this kit will help here. Tighten the 4-40 resistor mounting hardware. Solder the resistor from the "CIRCUIT SIDE" of the PCB making sure that the holes are completely filled with solder.

4. D3 and D5 are transient voltage suppressor diodes and are not supplied since the type (breakdown voltage) varies with the application. They are not necessary for every application. They are most commonly used in application circuits where kickback from the load may force the supply voltage above the limits of the amplifier.

5. The evaluation kit PCB can be mounted in several ways. **Option 1- Chassis mount.** Use #6 x  $\frac{1}{4}$ " M/F hex standoffs, and #6 nut (neither supplied) attached to the PCB at the four corners and center of the PCB and the chassis. **Option 2- Bench-top mount.** Use the five rubber bumpers supplied. These are "stick-on" components. Remove the release paper from each bumper and apply the bumper to the square outlines on the "CIRCUIT SIDE" of the PCB.

**Option 3- DIN rail mount.** The PCB can be mounted to either 1 or 2 DIN rails. For mounting the PCB to one DIN rail press the adaptors into the PCB in the holes at the edges of the PCB at locations 1 and 2 from the "CIRCUIT SIDE" of the PCB. Make sure that the plastic tines have fully spread out on the "DUT SIDE" of the PCB. If mounting to 2 DIN rails is desired, mount DIN rail adaptors at locations 3, 4, 5 and 6 in a similar manner. The center to center dimension of the DIN rails is to be 2.00" [50.8mm].

PowerAmp Design ♦ EVAL118 ♦ EVALUATION KIT FOR MODELS PAD115/ 118/ 119











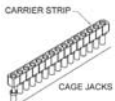





- 6. Components for locations R1-R7, D1, D2 are for the optional fold-over current limiting and are not supplied. Refer to the datasheet of the amplifier to find out how to apply circuits that require these components.
- 7. Remove the 4 hex nuts from the mounting spacers of the amplifier.
- 8. Align the 4 studs of the mounting spacers with the mounting holes in the PCB. Be sure that the amplifier's pin 1 aligns with pin 1 on the PCB. Slowly lower the amplifier into the PCB, making sure that the pins of the amplifier and the cage jacks mate. Push the amplifier into the PCB until the mounting spacers meet the PCB.
- 9. Fasten the amplifier to the PCB with the 4 hex nuts previously removed. Do not over-tighten the nuts as this may strip the mounting studs. The provided plastic nut starter can assist you here.
- 10. If necessary, strip 1/8" of insulation from the wires connected to the fan. Twist and tin the wire ends. Insert the red wire into the cage jack labeled "+" at the location marked "FAN" on the PCB. Likewise insert the blue or black wire into the cage jack labeled "-" at the location marked "FAN". Or, if you plan to use the PAD131 Fan Controller Accessory Module, insert the fan wires similarly into the "+" and "-" cage jacks at the location marked "Fan Control". Do not solder the fan wires into the PCB.
- 11. Add components as necessary to evaluate your application circuit. You can utilize the evaluation kit schematic and PCB views to map out your circuit and components. **Remember, if you are using the PAD125 Current Limit Accessory Module additional components or jumpers will be needed to program the operation of the module. See the PAD125 Current Limit Accessory Module datasheet.**
- 12. Remember that the amplifier **must** be compensated to operate correctly. See the amplifier datasheet on Page 4 under PHASE COMPENSATION. Your selected phase compensation capacitor will be installed at "C<sub>C</sub>" on the evaluation kit PCB. A 470pF capacitor has already been installed in the evaluation kit. Additionally, a 100pF compensation capacitor is also included in the kit. Replace C<sub>C</sub> as necessary for your application but keep in mind that C<sub>C</sub> must be rated for at least 300VDC. A temperature stable capacitor is required such as an NPO or X7R type.
- 13. If you have chosen to use the PAD125 accessory module install it at this time making sure that pin 1 on the module is aligned with the pin 1 marking on the PCB.
- 14. If you have chosen to use the PAD131 Fan Controller Accessory Module install it at this time making sure that pin 1 on the module is aligned with the pin 1 marking on the PCB. Double check that the wires from the fan are inserted into the jacks marked "Fan Control".
- 15. The evaluation kit assembly is complete. Be sure you have read and followed all the assembly steps. Do not forget

any jumpers that need to be installed. Inspect the circuit board for solder shorts or poor solder joints. An illuminated magnifier is helpful.

- 16. **Before applying power to your circuit set the power supply for ±20V and set the power supply current limit to approximately 100mA. Use little or no load at first. Apply an input signal and check the output with an oscilloscope to verify proper functionality. This step can prevent damaging the amplifier or the circuit board should there be some mistake in assembly.**

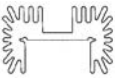
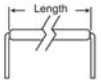
# EVAL118 EVALUATION KIT FOR MODELS PAD115/ PAD118/ PAD119 ILLUSTRATED PARTS LIST

*Note that the amplifier and accessory modules are purchased separately*

✓	Ref	Qty	Description	Mfg/Distributor	Mfg. Part Number	Illustration (not to scale)
<input type="checkbox"/>	Amplifier Pins 1-30 + TPs	3	Cage Jacks w/carrier strip 32 wide	Power Amp Design	CJS01	
<input type="checkbox"/>	C1, 2	2	Capacitor, 0.1uF, 630V	TDK	FK22X7R2J104KN000	
<input type="checkbox"/>	C3, 4	2	Electrolytic Capacitor, 330uF, 350V	Panasonic/Digi-Key	EET-HC2V331HF	
<input type="checkbox"/>	C5,6	2	Electrolytic Capacitor, 47uF 35V	Panasonic/Digi-Key	EEU-FC1V470	
<input type="checkbox"/>	JP1	1	BNC Jack	AMP/Digi-Key	5221123-2	
<input type="checkbox"/>	Cc	1	Capacitor, 470pF, 1kV	Vishay/Mouser	562R10TST47	
<input type="checkbox"/>	Cc	1	Capacitor, 100pF, 1kV	Vishay/Mouser	562R10TST10	
<input type="checkbox"/>	JP2	1	Terminal Block	Phoenix/Digi-Key	1729157	
<input type="checkbox"/>	TS1	1	Terminal Strip	Molex/Newark	38660-7807	
<input type="checkbox"/>	R <sub>s</sub>	3	Sense Resistor	Isotek Isotek Isotek	PBV-R005-1.0 (5mΩ) PBV-R010-1.0 (10mΩ) PBV-R015-1.0 (15 mΩ)	
<input type="checkbox"/>	D4, 6	2	Diode, Fast Recovery	ON Semi/Digi-Key	MUR460RL	
<input type="checkbox"/>	NA	5	Rubber Bumper	3M/Digi-Key	SJ5518	
<input type="checkbox"/>	HS1	1	Heat Sink	Wakefield/Mouser	67720ABP	
<input type="checkbox"/>	NA	15 (5ea)	Jumper	3M/Mouser	923345-01-C (0.1 in) 923345-02-C (0.2 in) 923345-03-C (0.3 in)	
<input type="checkbox"/>	NA	1	Nut Starter	Menda/Jensen Tool	200	
<input type="checkbox"/>	NA	1	Heat Sink Grease	NTE/Jameco	NTE303	
<input type="checkbox"/>	NA	1	4-40X1/2" screw & 4-40 nut	NA	NA	
<input type="checkbox"/>	NA	4	35mm DIN Rail Adaptor	Scidyne	121-0014	
<input type="checkbox"/>	NA	1	PCB	Power Amp Design	EVAL118	NA

PowerAmp Design ♦ EVAL118 ♦ EVALUATION KIT FOR MODELS PAD115/ 118/ 119

**CIRCUIT DIAGRAM**

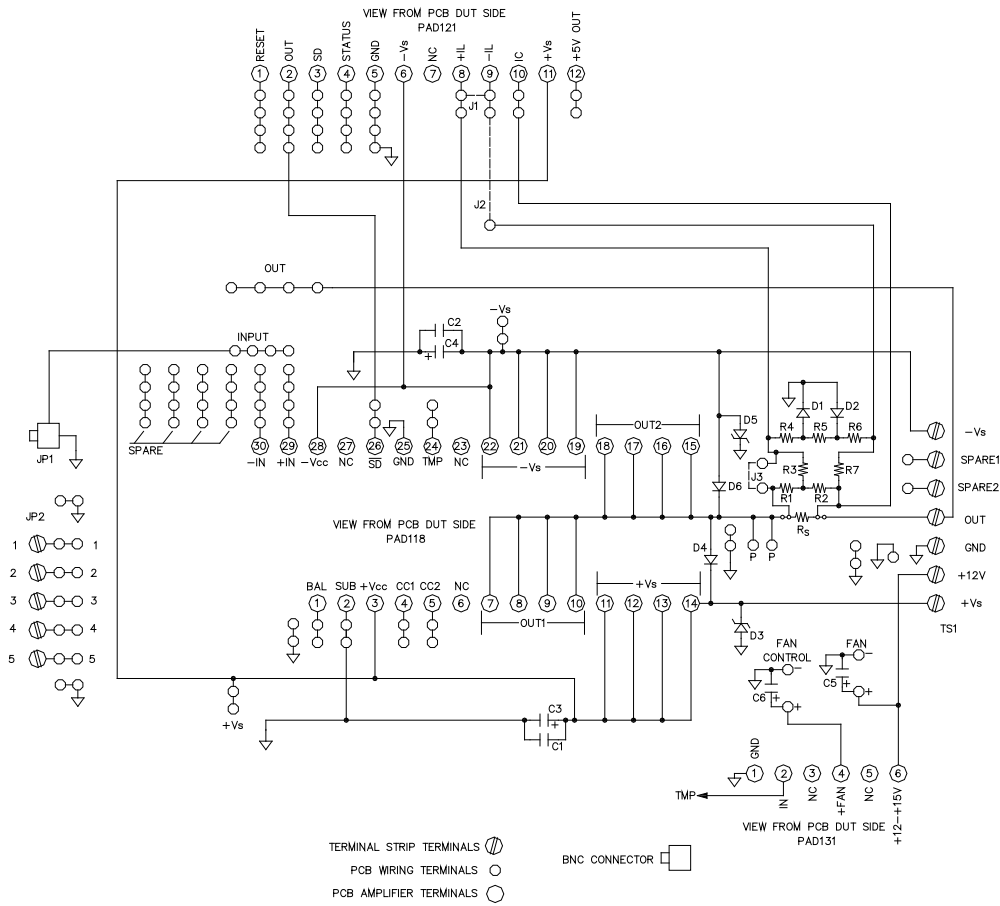

**JUMPER SELECTION**

**Option 1:** To use the amplifier and current limit accessory module together **without** fold-over current limit insert jumpers J1, 3. The kit comes wired with this option already installed.

**Option 2:** To use the amplifier and current limit accessory module together **with** fold-over current limit insert jumper J2.

Refer to the **PAD Power™** Excel spreadsheet (available for download from the website) for assistance in calculating resistor values for fold-over current limiting.

PowerAmp Design ♦ EVAL118 ♦ EVALUATION KIT FOR MODELS PAD115/ 118/ 119



Assembled EVAL118 with amplifier and optional accessory modules installed

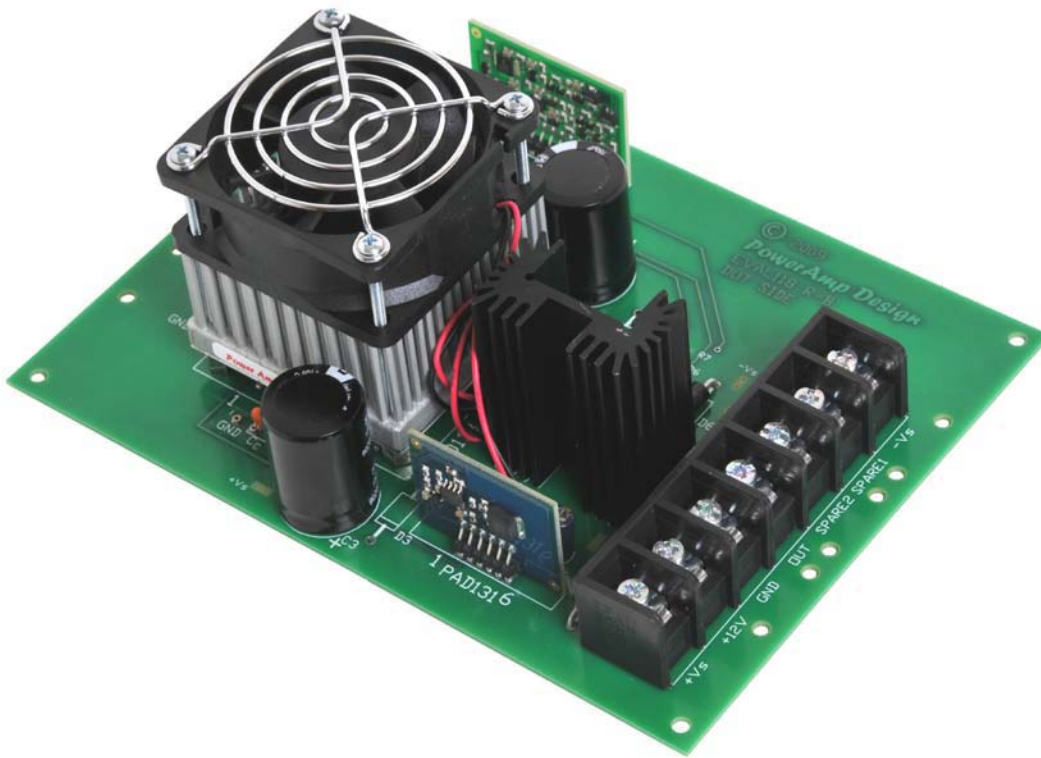

**PowerAmp Design** ♦ EVAL118 ♦ EVALUATION KIT FOR MODELS PAD115/ 118/ 119



**BOARD OUTLINE DIMENSIONS**

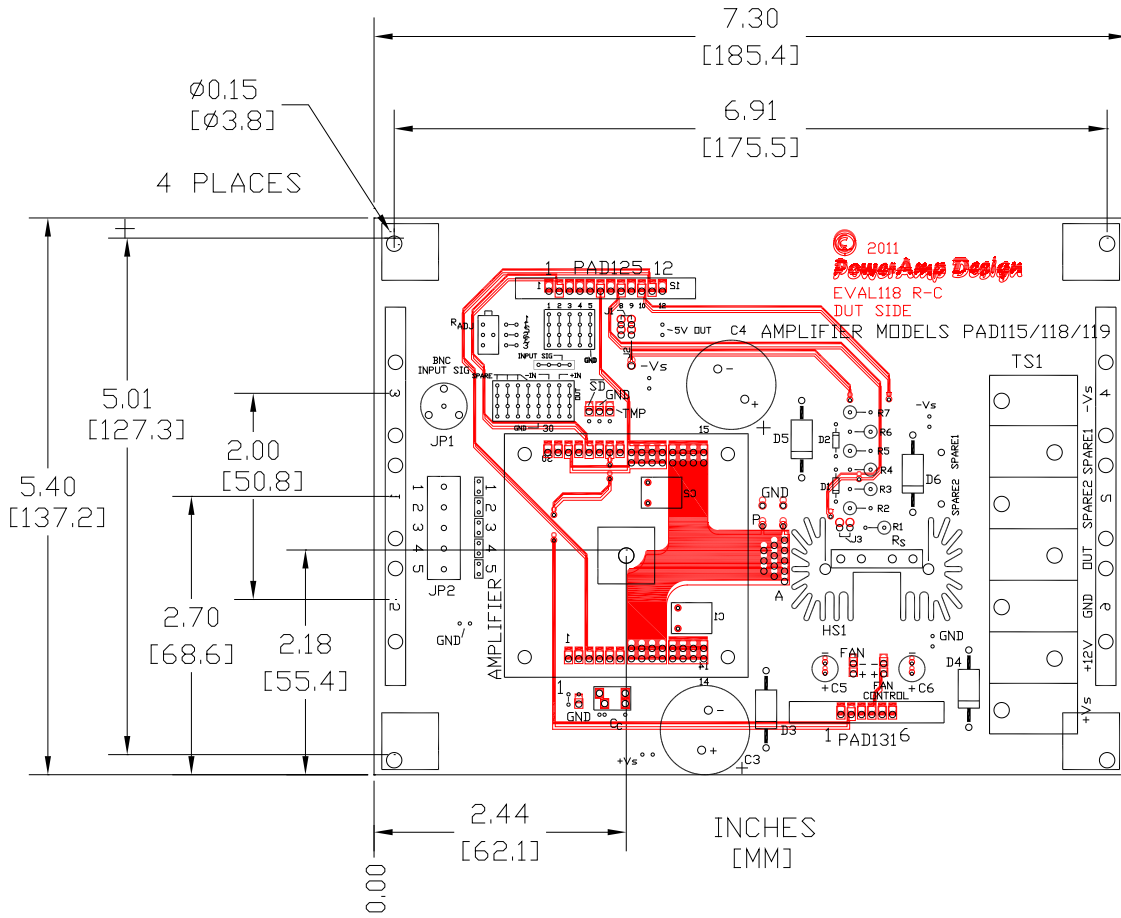

**PowerAmp Design** ♦ EVAL118 ♦ EVALUATION KIT FOR MODELS PAD115/ 118/ 119