

# PowerAmp Design

EVALUATION KIT FOR PAD126

EVAL126

Rev F

## INTRODUCTION

The EVAL126 assembled evaluation kit provides a convenient method to become familiar with the operation of the PAD126 operational amplifier before your application circuit is committed to production. Some assembly is required since some user selections are needed depending on the application. For example, a current limit resistor value needs to be selected by the user. Also, there are several PCB mounting options available.

Critical connections for power supply bypassing and compensation are pre-wired. Connections are also provided for implementing fold-over current limit as well as standard current limit with the optional PAD125 Current Limit Accessory Module. Fold-over current limit components are not provided since each application will have different requirements. Support is also provided for the PAD131 Fan Controller Accessory Module. Diode clamps on each power supply and the output connections are provided for those applications in which significant inductive kickback may be found. Terminal strips are also provided for input and output signals and power.

## ASSEMBLY STEPS

*Please note that the #1 cause of problems for evaluation kit users is not reading and following the directions (all of them). The #2 cause of problems is poor solder joints (cold or bridging). Don't become a statistic. ✓ each step.*

Refer to the Illustrated Parts List for the components mentioned in each assembly step. Some steps may require a soldering temperature higher than normal and/or a larger soldering iron tip. These steps are marked with an \*.

□ 1. Notice that the printed circuit board (PCB) is labeled on one side as the "DUT SIDE" and the other side as "CIRCUIT" side.

□ 2. As shown in the illustrated parts list, one or more of PAD's accessory cage jack strip CJS01 was used in the assembly of this kit. It may be advisable to use the cage jack strips in your production circuit board as well. The CJS01 cage jack sockets provide a convenient and inexpensive socket. Soldering and/or de-soldering the amplifier from the circuit board can be extremely difficult due to the high thermal conductivity of the amplifier's pins and substrate. You can find the datasheet for the CJS01 on the PAD website under the "Accessory Modules" tab.

□ 3. Refer to "Jumper Selection" below the Circuit Diagram for the EVAL126 on page 4. Install the required jumpers at the locations indicated depending on the options you have chosen. Jumpers for option 1 have already been installed. Remove and



Assembled EVAL126 with PAD126 mounted.

replace the jumpers as necessary for the options you have chosen. If you plan to use the optional PAD125 Current Limit Accessory Module refer to the data sheet for the PAD125 for complete information on how to program the operation of the PAD125.

□ 4.\* This step may require a soldering temperature higher than normal and/or a larger soldering iron tip. Four current limiting sense resistors,  $R_S$ , are provided; one 0.015 $\Omega$ , one 0.025 $\Omega$ , one 0.050 $\Omega$  and one 0.100 $\Omega$ . Refer to the data sheets for the PAD125 and PAD126 to determine which resistor value best fits your application. Smear a small amount of heat sink grease on the back of the selected resistor and then attach the resistor to heat sink HS1 at  $R_S$  with a 4-40 X 1/2" screw and nut. The plastic nut driver supplied with this kit will help here. Tighten the 4-40 resistor mounting hardware. Solder the resistor from the "CIRCUIT SIDE" of the PCB making sure that the holes are completely filled with solder.

□ 5. D3 and D5 are transient voltage suppressor diodes and are not supplied since the type (breakdown voltage) varies with the application. They are not necessary for every application. They are most commonly used in application circuits where kickback from the load may force the supply voltage above the limits of the amplifier.

□ 6. The evaluation kit PCB can be mounted in several ways. **Option 1- Chassis mount.** Use #6 x 1/4" M/F hex standoffs, #6 X 1/4" screw and #6 nut (not supplied) attached to the PCB at the four corners of the PCB and the chassis. Use one of the rubber bumpers supplied at the indicated place at the center of the amplifier on the "CIRCUIT SIDE" of the PCB.

PowerAmp Design ♦ EVAL126 ♦ EVALUATION KIT FOR PAD126

**Option 2- Bench-top mount.** Use the five rubber bumpers supplied. These are “stick-on” components. Remove the release paper from each bumper and apply the bumper to the square outlines on the “CIRCUIT SIDE” of the PCB.

**Option 3- DIN rail mount.** The PCB can be mounted to either 1 or 2 DIN rails. For mounting the PCB to one DIN rail press the adaptors into the PCB in the holes at the edges of the PCB at locations 1 and 2 from the “CIRCUIT SIDE” of the PCB. Make sure that the plastic tines have fully spread out on the “DUT SIDE” of the PCB. If mounting to 2 DIN rails is desired, mount DIN rail adaptors at locations 3, 4, 5 and 6 in a similar manner. The center to center dimension of the DIN rails is to be 2.00” [50.8mm].

**7.** Components for locations R1-R7, D1, D2 are for the optional fold-over current limiting and are not supplied. Refer to the data sheet of the PAD126 to find out how to apply circuits that require these components.

**8.** Remove the 4 hex nuts from the mounting spacers of the PAD126.

**9.** Align the 4 studs of the mounting spacers with the mounting holes in the PCB. Be sure that the amplifier’s pin 1 aligns with pin 1 on the PCB. Slowly lower the amplifier into the PCB, making sure that the pins of the amplifier and the cage jacks mate. Push the amplifier into the PCB until the mounting spacers meet the PCB.

**10.** Fasten the amplifier to the PCB with the 4 hex nuts previously removed. Do not over-tighten the nuts as this may strip the mounting studs. The provided plastic nut starter can assist you here.

**11.** If necessary, strip 1/8” of insulation from the wires connected to the fan twist and tin the wire ends. Insert the red wire into the cage jack labeled “+” and the black or blue wire into the jack marked “-” at the location marked “FAN”. Or, if you plan to use the PAD131 Fan Controller Accessory Module, insert the fan wires similarly into the “+” and “-” cage jacks at the location marked “Fan Control”.

**12.** Add components as necessary to evaluate your application circuit. You can utilize the evaluation kit schematic and PCB views to map out your circuit and components. **Remember, if you are using the PAD125 Current Limit Accessory Module additional components will be needed to program the operation of the module. See the PAD125 data sheet.**

**13.** The PAD126 **must** be compensated to operate correctly. See EXTERNAL CONNECTIONS DIAGRAM on page 2 of the datasheet for the PAD126. A table is provided relating the required compensation capacitor value for various circuit gains. Your selected phase compensation capacitor will be installed at “C<sub>c</sub>” on the evaluation kit PCB. A 100pF compensation capacitor has already been installed in the kit, but this value may not be the best value for your application. 33pF and 470pF capacitors are also provided. Remove and replace the capacitor











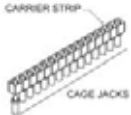

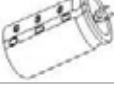





as necessary. The compensation capacitor must be rated for the total supply voltage (500V) and be temperature stable (X7R or NPO).

**14.** If you have chosen to use the PAD125 and/or PAD131 accessory module(s) install the module(s) at this time making sure that pin 1 of each module is aligned with the pin 1 markings on the PCB.

**15.** The evaluation kit assembly is complete. Be sure you have read and followed all the assembly steps. Do not forget any jumpers that need to be installed. Inspect the circuit board for solder shorts or poor solder joints. An illuminated magnifier is helpful.

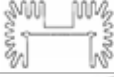
**16.** **Before applying power to your circuit set the power supply for ±20V and set the power supply current limit to approximately 100mA. Use little or no load at first. Apply an input signal and check the output with an oscilloscope to verify proper functionality. This step can prevent damaging the amplifier or the circuit board should there be some mistake in assembly.**

*Note that the PAD126, PAD131 and PAD125 are purchased separately.*

✓	Ref	Qty	Description	Mfg/Distributor	Mfg. Part Number	Illustration (not to scale)
<input type="checkbox"/>	Amplifier Pins 1-46 + TPs	3	Cage Jacks w/carrier strip 32 wide	Power Amp Design	CJS01	
<input type="checkbox"/>	C1,2,7,8	4	Chip Capacitor, 0.20uF, 500V	Novacap	1825B204M501NT	
<input type="checkbox"/>	C3, 4	2	500V Electrolytic Capacitor, 150uF	Panasonic/Digi-Key	ECOS2HP151CA	
<input type="checkbox"/>	C5,6	2	35V Electrolytic Capacitor, 47uF	Panasonic/Digi-Key	BEU-FC1V470	
<input type="checkbox"/>	C <sub>c</sub>	1	Ceramic Capacitor, 470pF, 1kV	Sprague/Mouser	562R5GAT47	
<input type="checkbox"/>	C <sub>c</sub>	1	Ceramic Capacitor, 100pF, 1kV	Sprague/Mouser	562R5GAT10	
<input type="checkbox"/>	C <sub>c</sub>	1	Ceramic Capacitor, 33pF, 1kV	Sprague/Mouser	561R10TCCQ33	
<input type="checkbox"/>	JP1	1	BNC Jack	AMP/Digi-Key	5221123-2	
<input type="checkbox"/>	JP2	1	Terminal Block	Phoenix/Digi-Key	1729157	
<input type="checkbox"/>	TS1	1	Terminal Strip	Molex/Newark	38660-7807	
<input type="checkbox"/>	R <sub>s</sub>	4	Sense Resistor	Isotek Isotek Isotek Isotek	PBV-R050-1.0 (50mΩ) PBV-R100-1.0 (100mΩ) PBV-R015-1.0 (15mΩ) PBV-R025-1.0 (25 mΩ)	
<input type="checkbox"/>	D4, 6	2	Diode, Fast Recovery	ON Semi/Digi-Key	MUR460RL	
<input type="checkbox"/>	NA	5	Rubber Bumper	3M/Digi-Key	SJ5518	
<input type="checkbox"/>	NA	15 (5ea)	Jumper	3M/Mouser	923345-01-C (0.1 in) 923345-02-C (0.2 in) 923345-03-C (0.3 in)	
<input type="checkbox"/>	HS1	1	Heat Sink	Wakefield/Mouser	67725ABP	
<input type="checkbox"/>	NA	1	Nut Starter	Menda/Jensen Tool	200	
<input type="checkbox"/>	NA	1	Heat Sink Grease	NTE/Jameco	NTE303	
<input type="checkbox"/>	NA	1	4-40X1/2" screw & 4-40 nut	NA	NA	
<input type="checkbox"/>	NA	4	35mm DIN Rail Adaptor	Scidyne	121-0014	
<input type="checkbox"/>	NA	1	PCB	Power Amp Design	EVAL126	NA

Power Amp Design ♦ EVAL126 ♦ EVALUATION KIT FOR PAD126

CIRCUIT DIAGRAM

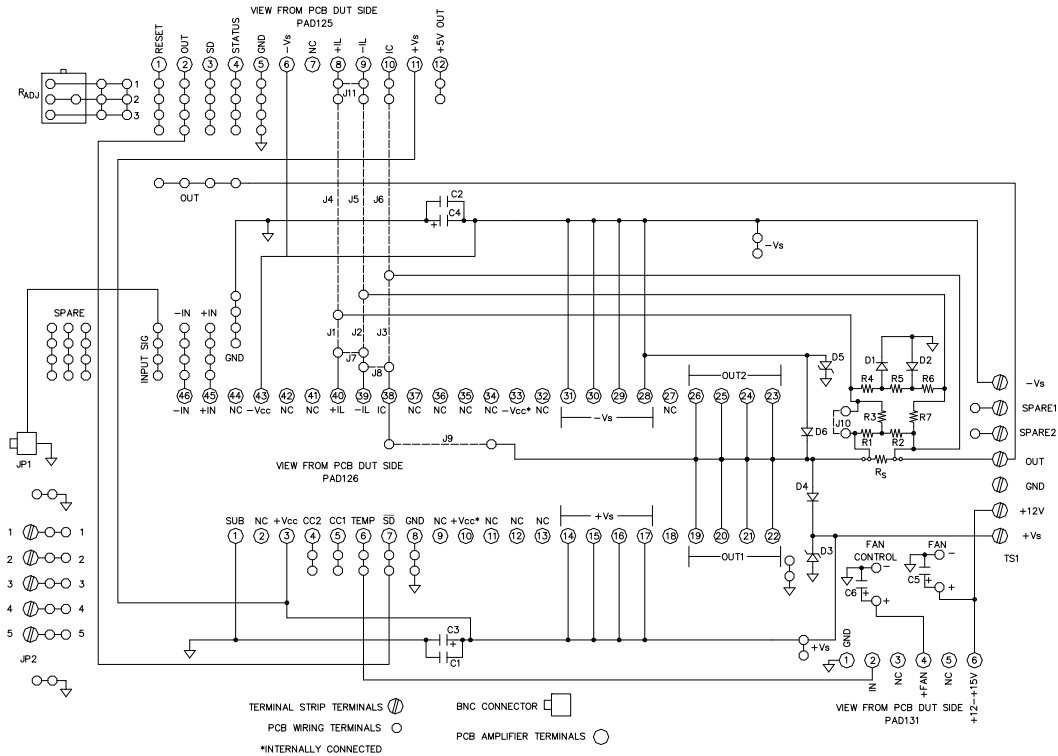

JUMPER SELECTION

Option 1: To use the PAD126 **without** fold-over current limit insert jumpers J1, 3, 7, 10. The kit comes with jumpers for this option already installed.

Option 2: To use the PAD126 **with** fold-over current limit insert jumpers J1, 2, 3.

Option 3: To use the PAD126 and PAD125 together **without** fold-over current limit insert jumpers J4, 6, 7, 8, 9, 10, 11.

Option 4: To use the PAD126 and PAD125 together **with** fold-over current limit insert jumpers J4, 5, 6, 7, 8, 9.

TOP VIEW

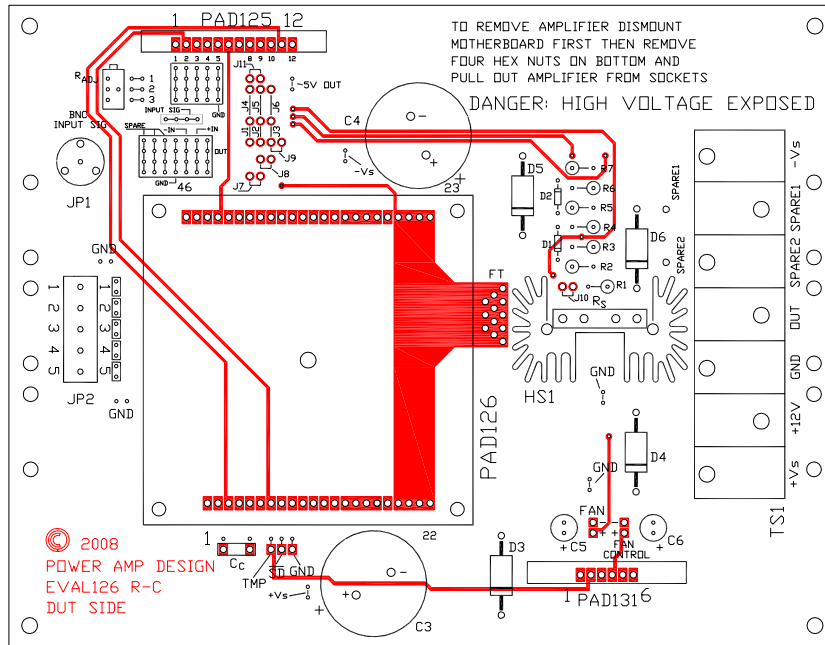

BOTTOM VIEW

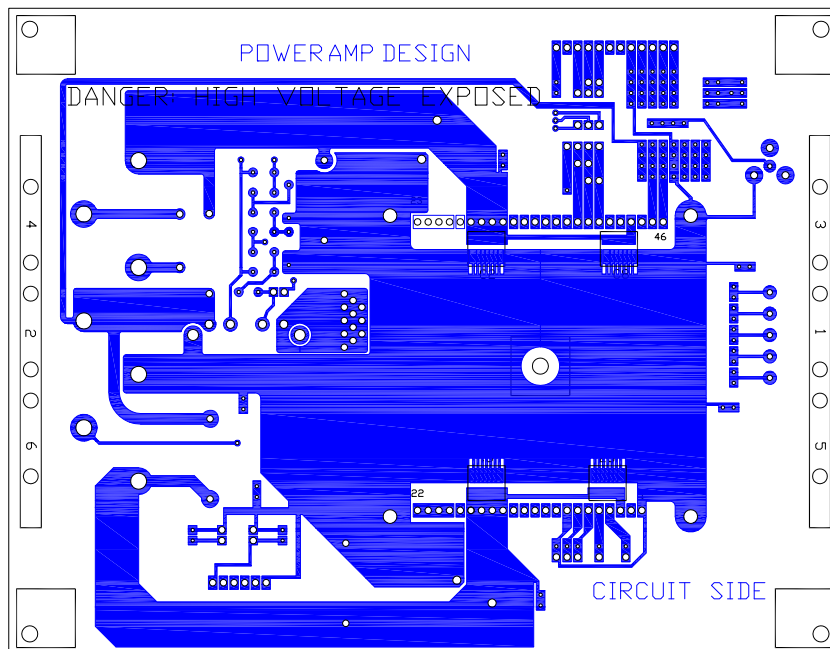

Power Amp Design ♦ EVAL126 ♦ EVALUATION KIT FOR PAD126



EVAL126 with PAD126 mounted and also optional accessory modules PAD125 and PAD131 installed



BOARD OUTLINE DIMENSIONS

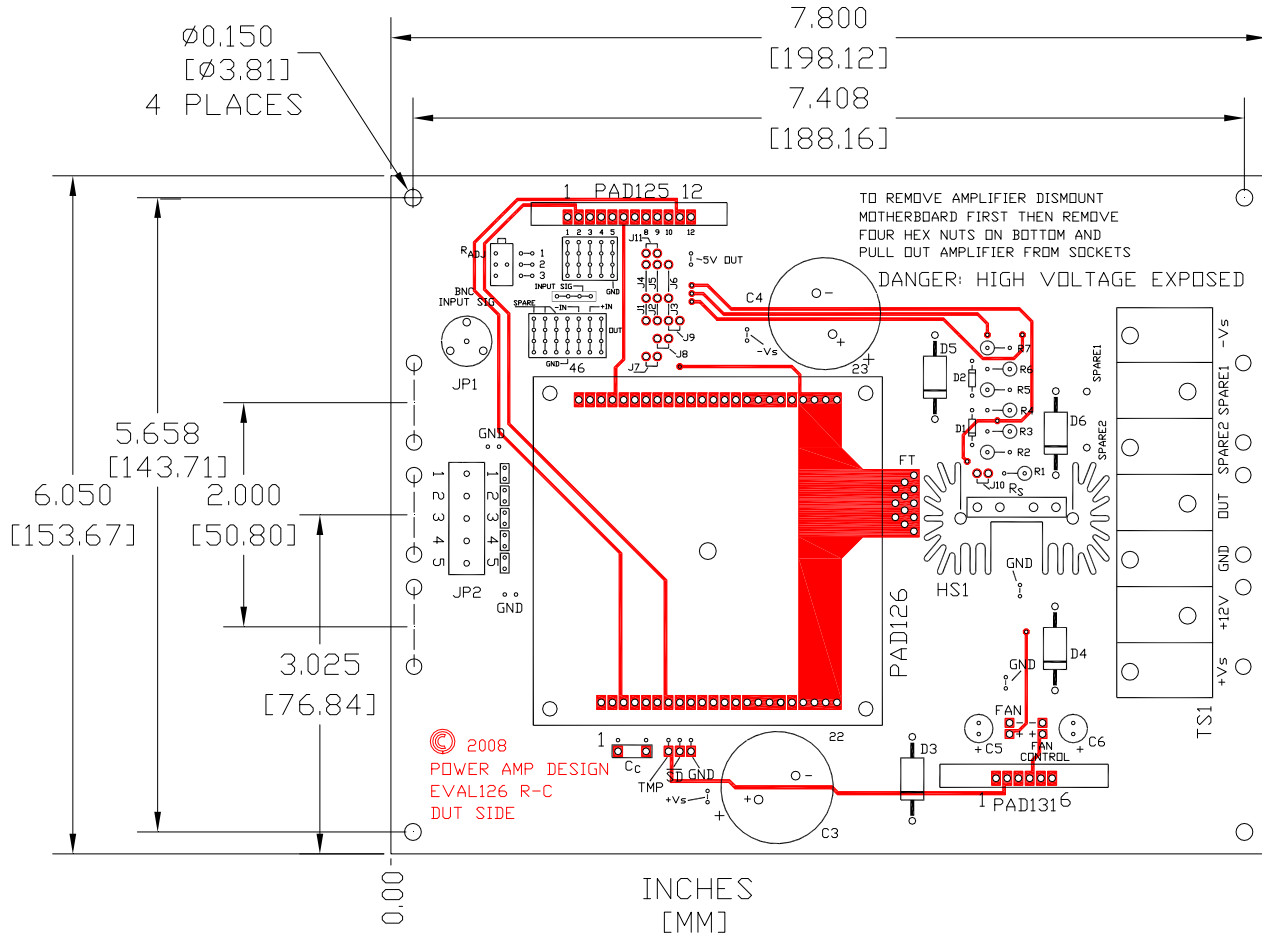

Power Amp Design ♦ EVAL126 ♦ EVALUATION KIT FOR PAD126