

PowerAmp Design

POWER OPERATIONAL AMPLIFIER

PAD108

Rev D

KEY FEATURES

- LOW COST
- HIGH VOLTAGE – 200 VOLTS
- HIGH CURRENT – 10 AMPS
- 100 WATT DISSIPATION CAPABILITY
- 300kHz POWER BANDWIDTH

APPLICATIONS

- INKJET PRINTER HEAD DRIVE
- PIEZO TRANSDUCER DRIVE
- INDUSTRIAL INSTRUMENTATION
- RELECTOMETERS
- ULTRA-SOUND TRANSDUCER DRIVE

DESCRIPTION

The PAD108 is a high voltage operational amplifier constructed with surface mount components to provide a cost effective solution for many industrial applications. With a footprint only 3.3in² the PAD108 offers outstanding performance that rivals more expensive hybrid component amplifiers. User selectable external compensation tailors the amplifier's response to the application requirements. Four-wire current limit is built-in. The amplifier circuitry is built on a thermally conductive but electrically insulating substrate. No BeO is used in the PAD108. The resulting module is a small, high performance solution for many industrial applications.

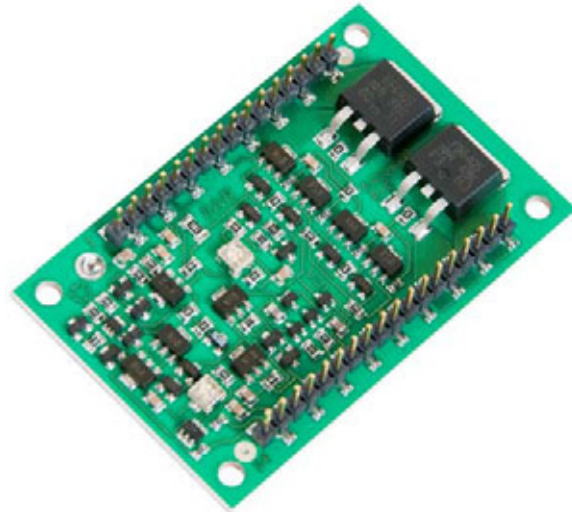

PowerAmp Design ♦ PAD108 ♦ POWER OPERATIONAL AMPLIFIER

EQUIVALENT CIRCUIT

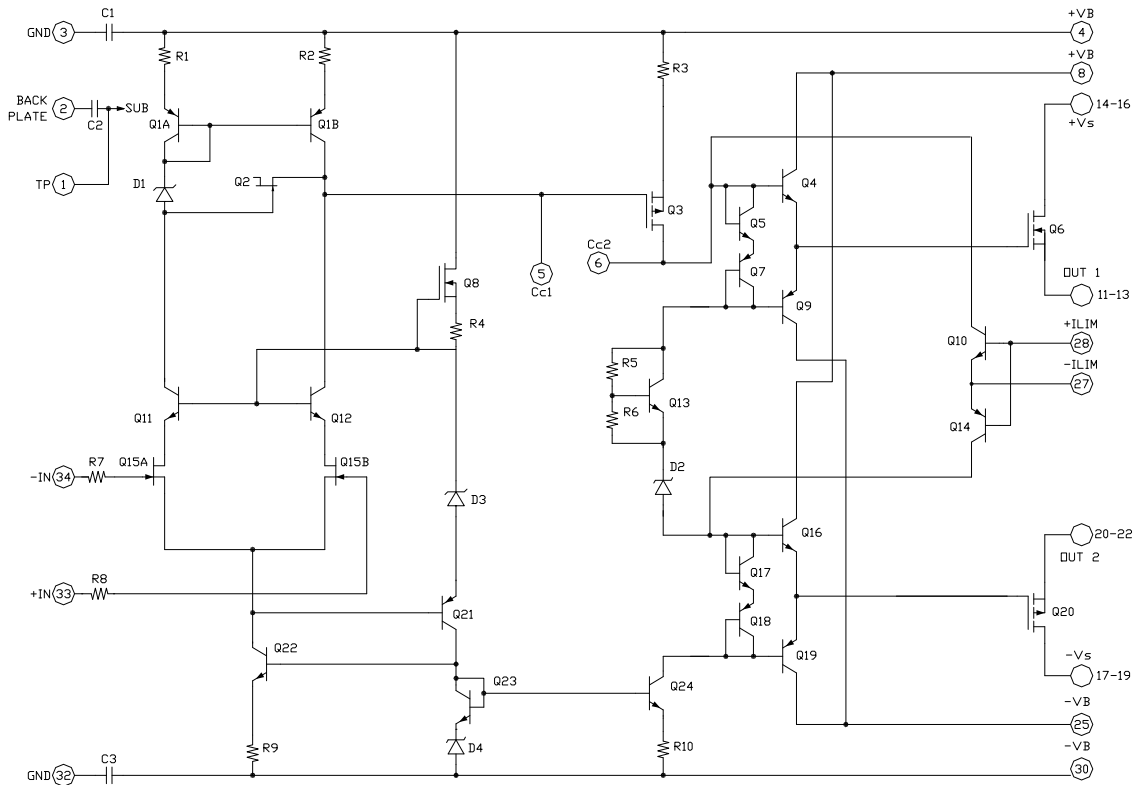

PINOUT & CONNECTIONS

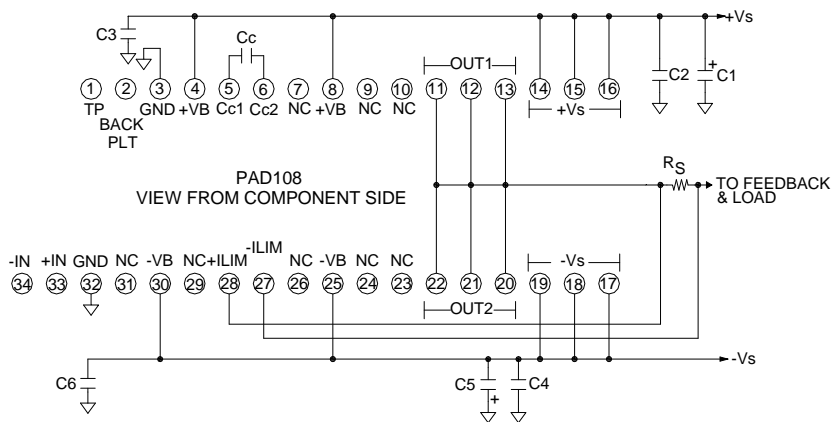

NOTES:

1. Cc IS NPO (COG) RATED FOR FULL SUPPLY VOLTAGE +Vs TO -Vs
2. BOTH PINS 3 AND 32 ARE REQUIRED CONNECTED TO SIGNAL GROUND
3. C1 AND C5 ELECTROLYTIC, 10uF PER AMP OUTPUT CURRENT
4. C2,3,4,6 HIGH QUALITY CERAMIC 0.1uF
5. ALL OUTPUT PINS MUST BE TIED TOGETHER

PHASE COMPENSATION		
GAIN W/O BOOST	Cc	SLEW RATE
1	100pF	55V/uS
4	33pF	135V/uS
≥ 10	10pF	170V/uS
GAIN W BOOST		
GAIN W/O BOOST	Cc	SLEW RATE
1	470pF	12V/uS
3	220pF	35V/uS
≥ 10	33pF	135V/uS

PowerAmp Design ♦ PAD108 ♦ POWER OPERATIONAL AMPLIFIER

ABSOLUTE MAXIMUM RATINGS			
SUPPLY VOLTAGE, +V _S to -V _S	200V	TEMPERATURE, pin solder, 10s	237°C
BOOST VOLTAGE,	±V _S ±20V	TEMPERATURE, junction ²	150°C
OUTPUT CURRENT, within SOA	12A	TEMPERATURE RANGE, storage	-40 to 105°C
POWER DISSIPATION, internal, DC	100W	OPERATING TEMPERATURE, case	-40 to 85°C
INPUT VOLTAGE, differential	± 20V		
INPUT VOLTAGE, common mode	±V _B		

PARAMETER	TEST CONDITIONS ¹	MIN	TYP	MAX	UNITS
INPUT					
OFFSET VOLTAGE			1	3	mV
OFFSET VOLTAGE vs. temperature	Full temperature range		20	50	μV/°C
OFFSET VOLTAGE vs. supply				20	μV/V
BIAS CURRENT, initial ³				100	pA
BIAS CURRENT vs. supply				0.1	pA/V
OFFSET CURRENT, initial				50	pA
INPUT RESISTANCE, DC			100		G Ω
INPUT CAPACITANCE			4		pF
COMMON MODE VOLTAGE RANGE				+V _B -15	V
COMMON MODE VOLTAGE RANGE				-V _B +7	V
COMMON MODE REJECTION, DC		98	106		dB
NOISE	100kHz bandwidth, 1kΩ R _S		10		μV RMS
GAIN					
OPEN LOOP	R _L = 10kΩ, C _C =10pF	108			dB
GAIN BANDWIDTH PRODUCT @ 1MHz	C _C =10pF		10		MHz
PHASE MARGIN	Full temperature range	45	60		degree
OUTPUT					
VOLTAGE SWING	I _O = 10A	±V _S -10	+V _S -8.6		V
VOLTAGE SWING	I _O = -10A	-V _S +10	-V _S +7		V
VOLTAGE SWING	+V _B =+V _S +10V, I _O = 10A	+V _S -1.6	+V _S -1.2		
VOLTAGE SWING	-V _B =-V _S -10V, I _O = -10A	-V _S -5.1	+V _S +4.1		
CURRENT, continuous, DC		11			A
SLEW RATE, A _V = -10	C _C = 10pF	150	170		V/μS
SETTLING TIME, to 0.1%	2V Step, C _C = 10pF		1		μS
RESISTANCE	No load, DC		4		Ω
POWER BANDWIDTH, 180Vp-p	C _C = 10pF		300		kHz
POWER SUPPLY					
VOLTAGE		± 15	± 75	± 100	V
CURRENT, quiescent			50	65	mA
THERMAL					
RESISTANCE, AC, junction to case ⁵	Full temperature range, f ≥ 60Hz			1	°C/W
RESISTANCE, DC junction to case	Full temperature range			1.25	°C/W
RESISTANCE, DC junction to air	Full temperature range			13	°C/W
TEMPERATURE RANGE, case		-40		85	°C

NOTES:

1. Unless otherwise noted: T_C = 25°C, compensation C_C = 100pF, DC input specifications are ± value given, power supply voltage is typical rating.
2. Derate internal power dissipation to achieve high MTBF.
3. Doubles for every 10°C of case temperature increase.
4. +V_S and -V_S denote the positive and negative supply voltages to the output stage. +V_B and -V_B denote the positive and negative supply voltages to the input stages.
5. Rating applies if the output current alternates between both output transistors at a rate faster than 60Hz.
7. Power supply voltages +V_B and -V_B must not be less than +V_S and -V_S respectively. Total voltage +V_B to -V_B 240V maximum.
8. The PAD108 is constructed with MOSFET transistors and ESD handling procedures must be observed.

SAFETY FIRST

The operating voltages of the PAD108 are potentially deadly. When developing an application circuit it is wise to begin with power supply voltages as low as possible while checking for circuit functionality. Increase supply voltages slowly as confidence in the application circuit increases. Always use a “hands off” method whereby test equipment probes are attached only when power is off.

CURRENT LIMIT

The current limiting function of the PAD108 is a versatile circuit that can be used to implement a four-wire current limit configuration. The four-wire current limit configuration insures that parasitic resistance in the output line, R_p , does not affect the programmed current limit setting. See Figure 1 below. The sense voltage for current limit is 0.7V. Thus:

$$I_L = \frac{0.65V}{R_s}$$

Where I_L is the value of the limited current and R_s is the value of the current limit sense resistor.

In addition, the sense voltage has a temperature coefficient approximately equal to $-2.2\text{mV}/^\circ\text{C}$.

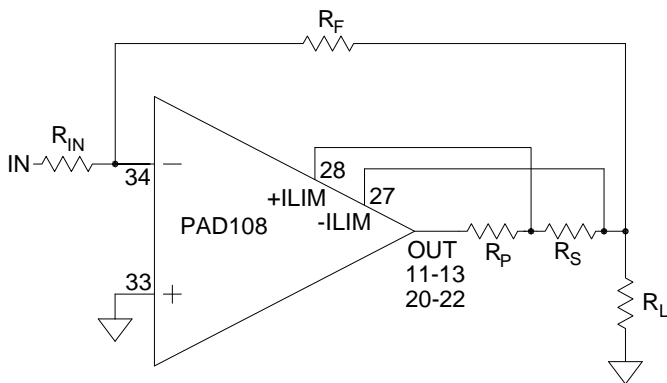

Figure 1

MOUNTING THE AMPLIFIER

In most applications the amplifier must be attached to a heat sink. Spread a thin and even coat of heat sink grease across the back of the PAD108 and also the heat sink where the amplifier is to be mounted. Push the amplifier into the heat sink grease on the heat sink while slightly twisting the amplifier back and forth a few times to bed the amplifier into the heat sink grease. On the final twist align the mounting holes of the amplifier with the mounting holes in the heat sink and finish the

mounting using 4-40 hex male-female spacers. Mount the amplifier to the mother board with 4-40 X 1/4" screws.

PHASE COMPENSATION

The PAD108 **must** be phase compensated. The compensation capacitor, C_C , is connected between pins 5 and 6. The compensation capacitor must be an NPO type capacitor rated for the full supply voltage (200V). On page 2, under Amplifier Pinout and Connections, you will find a table that gives recommended compensation capacitance value for various circuit gains and the resulting slew rate for each capacitor value. Consult also the small signal response and phase response plots for the selected compensation value in the Typical Performance Graphs section. Do not use a compensation capacitor less than 10pF.

BOOST OPERATION

The small signal stages of the PAD108 are connected to the $\pm V_B$ power supply pins. When the $\pm V_B$ voltages are greater than the $\pm V_S$ power supply pins the small signal stages of the amplifier are biased so that the output transistors can be driven very close to the $\pm V_S$ rails. Close swings to the supply rails increase the efficiency of the amplifier and make better use of the supply voltages. This technique is often used to operate the amplifier with only a single high current power supply, thus reducing the system size and cost. Also see the application article AN-22 *Single Supply Operation with Power Op Amps* for more detailed information and circuits.

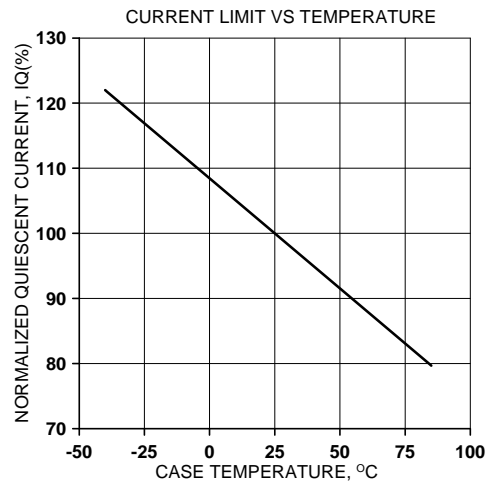
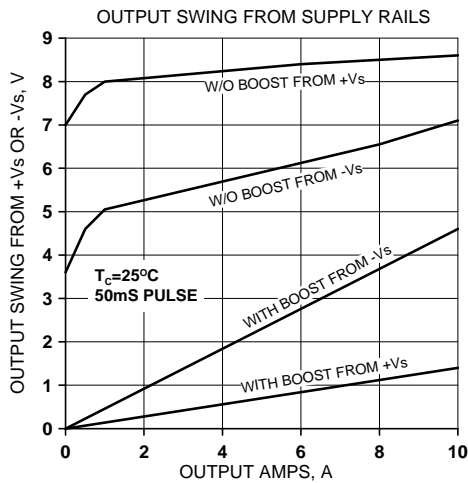
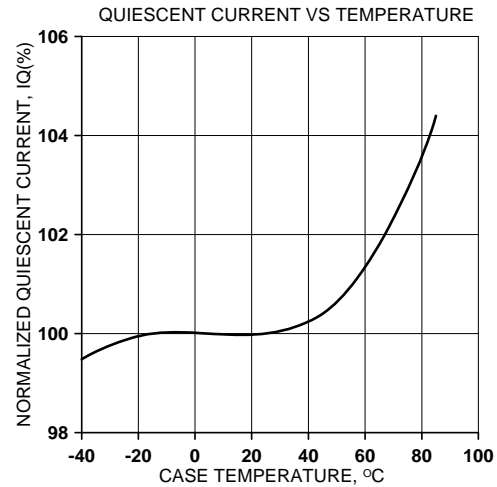
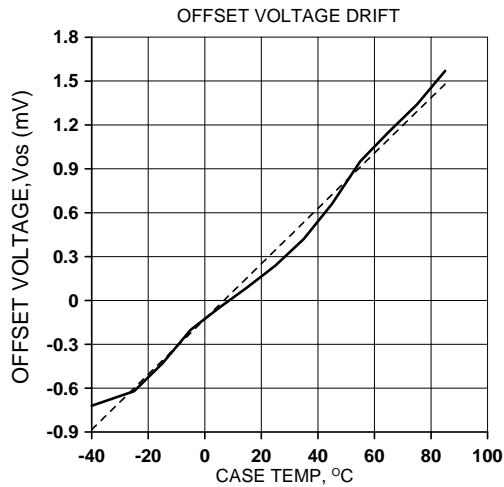
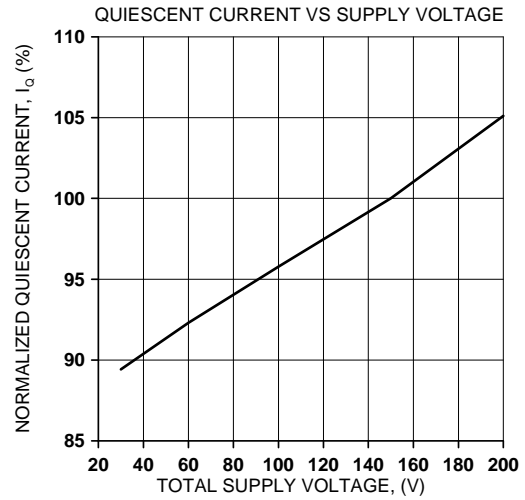
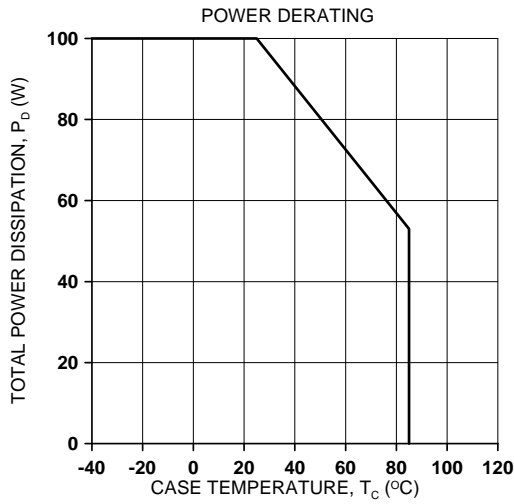

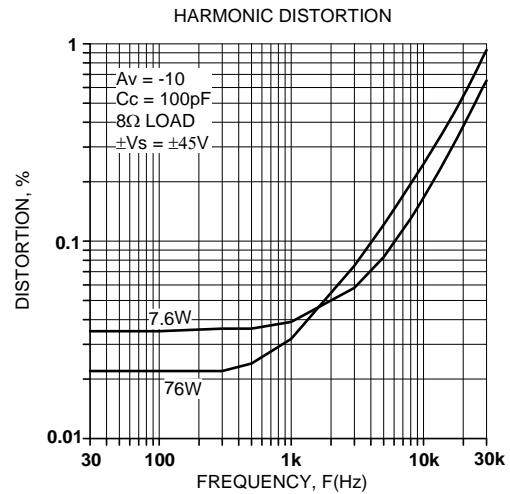
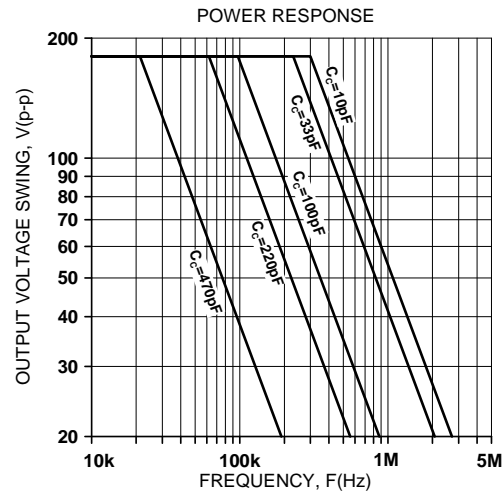
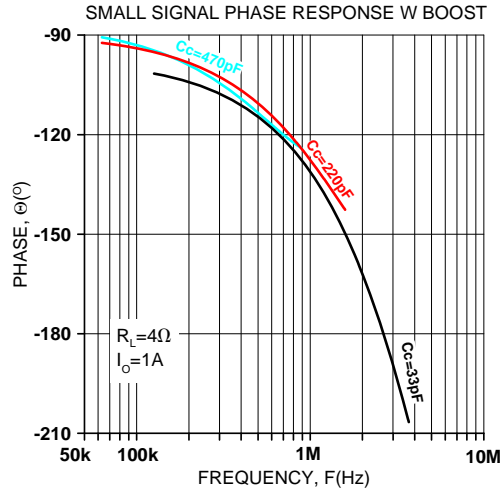
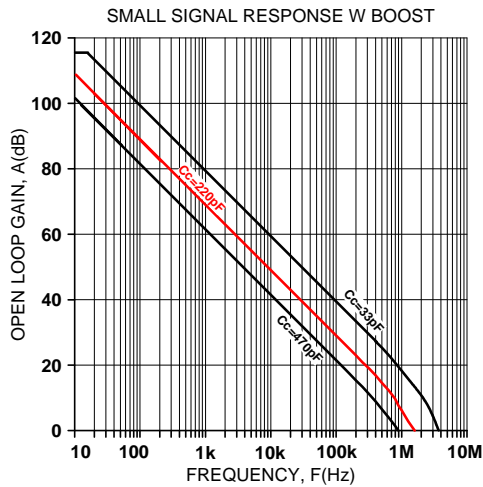
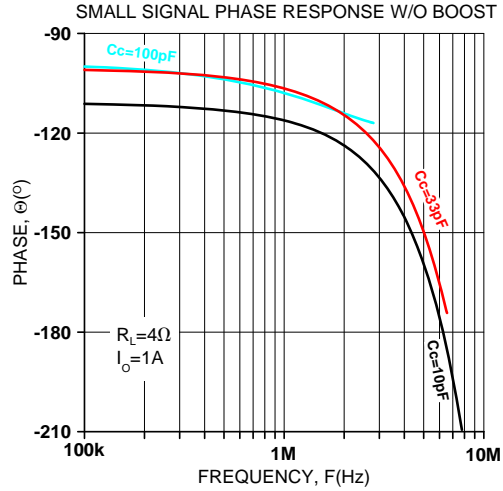
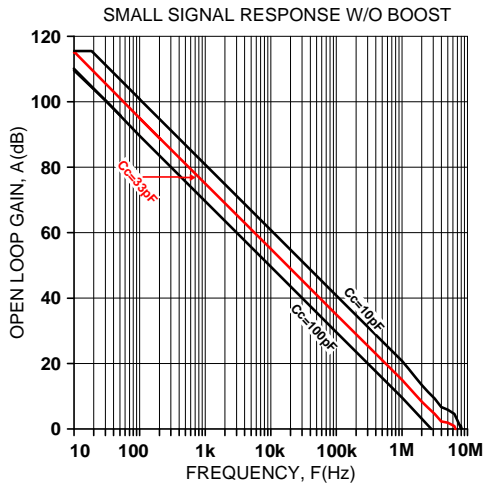

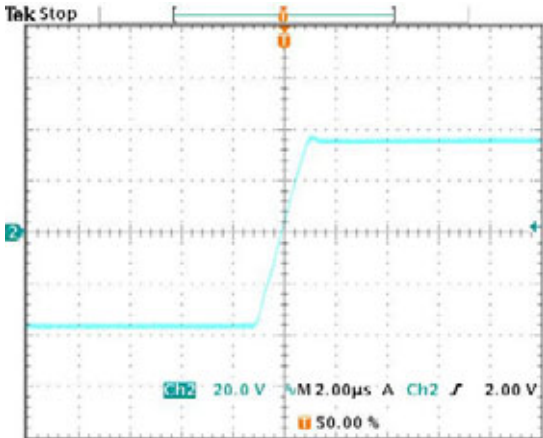

Pos. Pulse response, $G=-10$, $C_C=100\text{pF}$, 47nF load

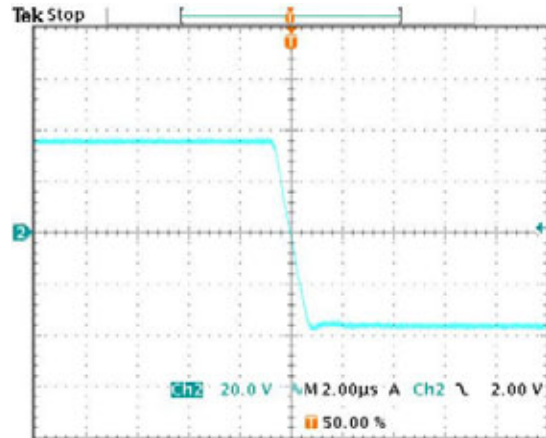

Neg. Pulse response, $G=-10$, $C_C=100\text{pF}$, 47nF load

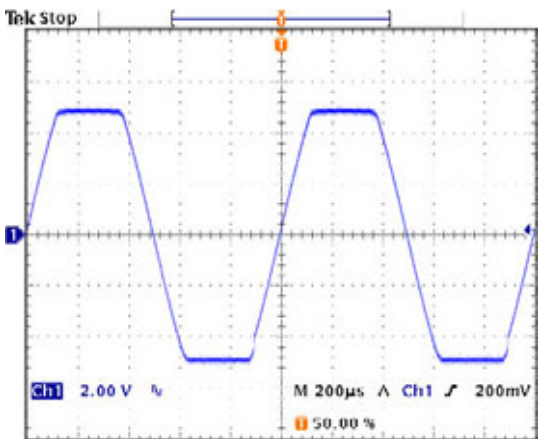

1kHz sine clipped by current limit into 100Ω load

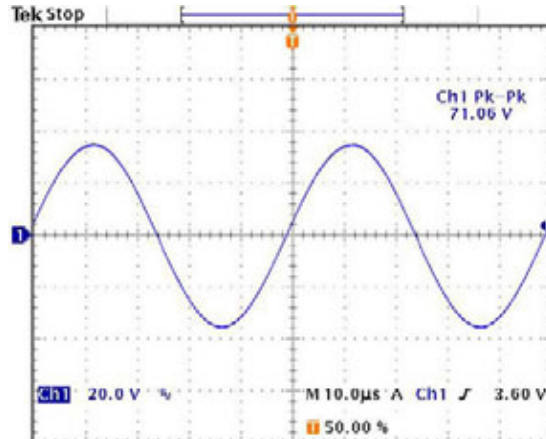

20kHz sine into 8Ω load, $G=-10$, $C_C=100\text{pF}$

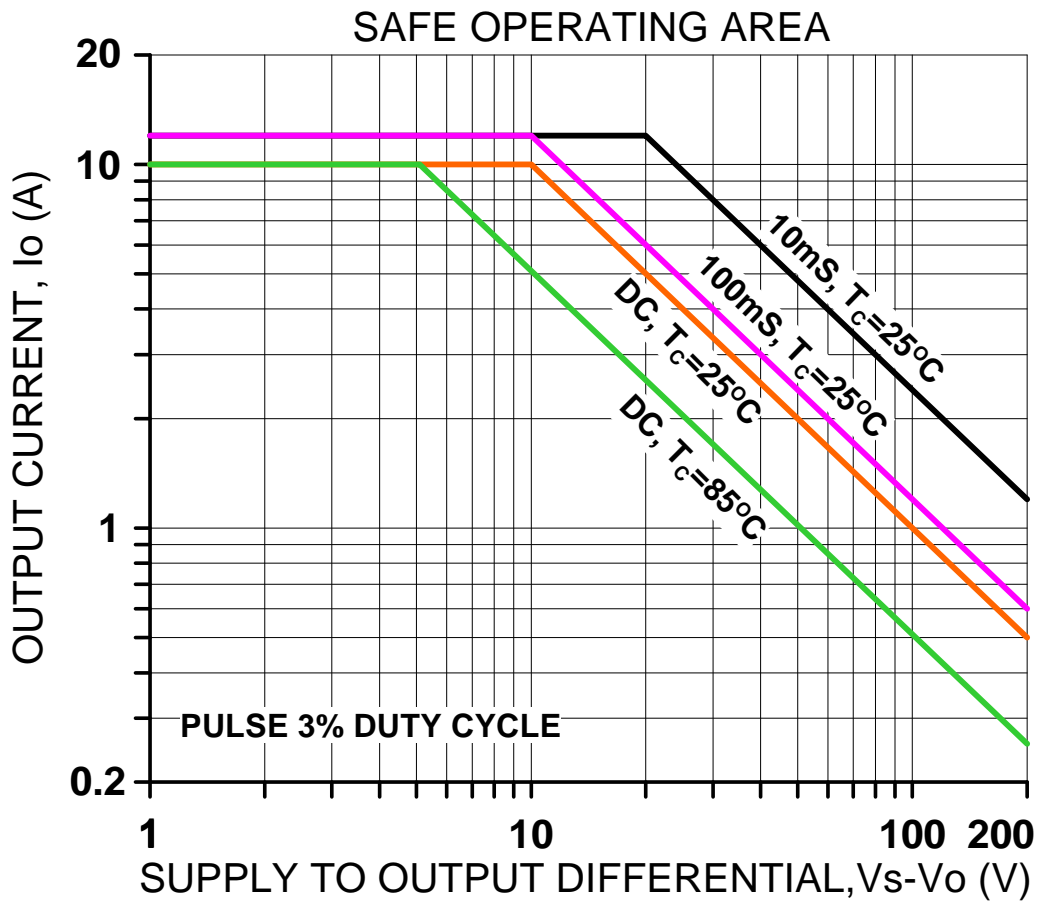

SAFE OPERATING AREA

PowerAmp Design ♦ PAD108 ♦ POWER OPERATIONAL AMPLIFIER

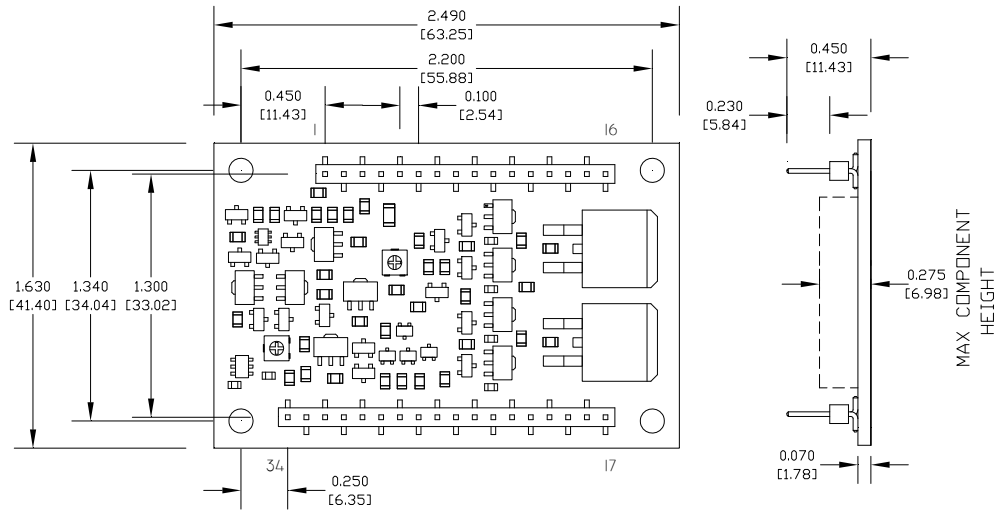

- NOTES: 1: DIMENSIONS ARE INCHES, [mm]
 2: PINS 0.025" SQUARE [0.635mm], GOLD PLATED
 3: RECOMMENDED HOLE FOR MOUNTING 0.129" D. x2 [3.277mm]
 4: RECOMMENDED HOLE FOR PINS 0.052" D. [1.321mm]
 5: HIGHLY RECOMMENDED THAT AMPLIFIER IS MOUNTED INTO CAGE JACKS USING PAD PART NUMBER CJS01. USE 0.062" [1.575mm] HOLE FOR CAGE JACKS.
 6: HIGHLY RECOMMENDED THAT AMPLIFIER IS MOUNTED INTO HEAT SINK WITH 4-40 M/F SPACERS TO PROVIDE STRAIN RELIEF FOR PINS. SEE DRAWING BELOW.

